

扫码联系我

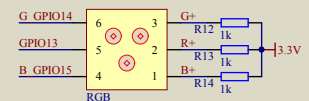
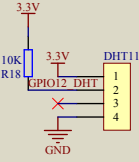
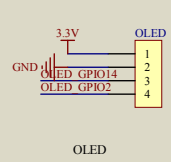
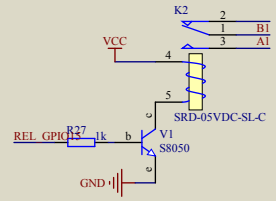
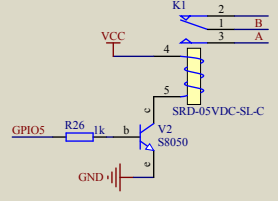
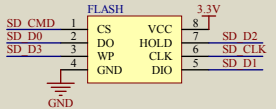
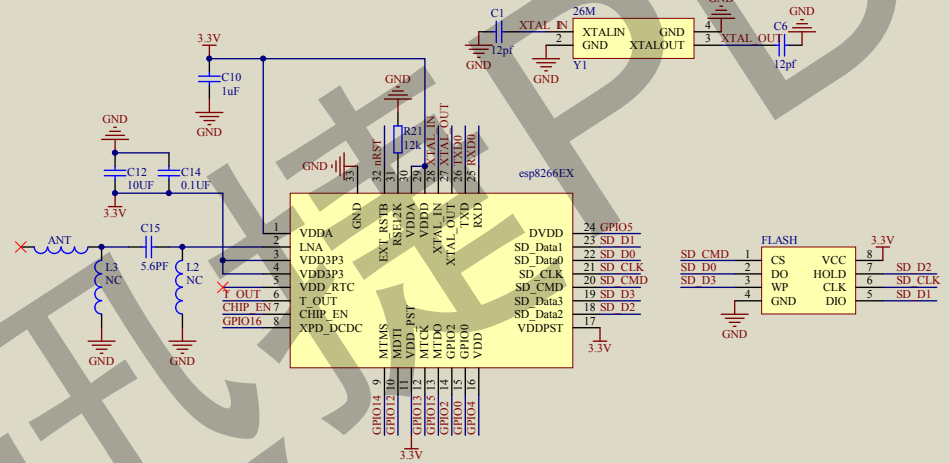
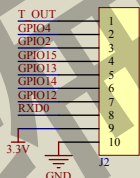
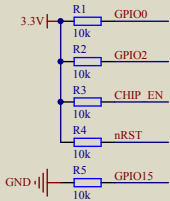
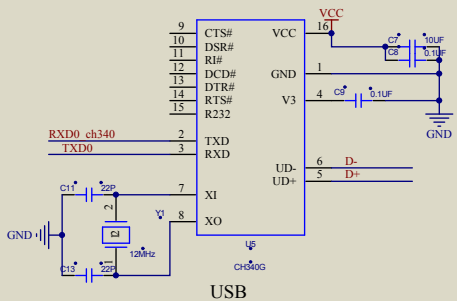

Title		
Size	Number	Revision
A3		
Date:	2018/6/9	Sheet of
File:	D:\WIFI\wifi.Sch.Doc	Drawn By: